

Brunata

Technical Manual for HGP-series

– Volume and Energy Meters, 15 to 600 m³/h

Brunata HG meters

In 1999 Brunata took over HG International a/s, a modern wholly Danish owned company focusing on the development and production of electronic water and energy meters based on the magnetic induction metering principle. Thanks to an unswerving commitment to new technology we today supply some of the most advanced, reliable and accurate meters on the market.

Since production began in 1953 the HG meters have undergone a considerable transformation. They have changed from being mechanical to fully electronic devices without a single moving part. The electronics have become increasingly compact, and the functionality has expanded enormously. Today's meters are like small computers, with all the software contained on a single integrated circuit.

Today, our range of products includes meters for hot and cold water and for energy metering in heating and cooling systems. We offer one of the widest selections of meters on the market, covering capacities from 1 l/h to 660 m³/h.

The Brunata Group

Brunata is a wholly Danish owned production and engineering company with approx. 400 employees that develops and manufactures mechanical and electronic equipment for the metering of heat and water and that also prepares the associated billing. In Denmark, Brunata has its head office in the outskirts of Copenhagen and is represented nationwide through local branches. Furthermore, the company exports to most European countries through subsidiaries and license partners.

Table of contents

	Brunata HG meters	2	5	Pressure ratings and flow ranges	10
1	Introduction	4	6	Terminal connection	11
	1.1 Reference documents	4	6.1	High resolution volume pulse output .	12
2	General description	4		6.1.1 The values of the high resolution (HF-) volume pulses	12
	2.1 Design overview	4	6.2	Low resolution volume output.....	13
	2.2 Volume meter	5		6.2.1 Maximum flow without calculator..	13
	2.3 Heat energy meter	5		6.2.2 Maximum flow with calculator..	13
	2.4 Flow sensors	5	7	Data communication	14
	2.5 Electronics	5	7.1	RS232 module	1
	2.6 Temperature sensors	6	7.2	M-Bus module	14
	2.6.1 Direct sensors.....	6	7.3	LON module	14
	2.6.2 Pocket sensors	6	7.4	Analogue output device.....	14
	2.7 Type approvals	6	7.5	Communication	14
	2.8 Accuracy.....	6	8	Test and adjustment.....	15
	2.9 Types and versions	6	8.1	Calibration / Verification.....	15
3	Operating principles	8	8.2	Service Instruments.....	15
	3.1 Volume measuring and signal processing	8		8.2.1 HG-SER 40	15
	3.2 HGP volume meter with HGS Integrator.....	8		8.2.2 HG-SER 44.....	15
	3.3 Temperature measuring	9	9	Change of display functions	15
	3.4 Energy calculation.....	9	9.1	Zeroing of peak values	15
	3.5 Display functions.....	9	9.2	Date and Clock adjustment.....	15
	3.6 Flow rates above q_{max}	9	9.3	Battery	15
	3.7 Info and error codes, self test	9	10	Installation requirements	16
4	Dimensions	10	10.1	Installing the flow sensor	16
	4.1 Flow sensors	10	10.2	Mounting and Connections of the Electronic Unit	16
	4.2 Electronics	10	10.3	Temperature sensors	16
	4.3 Temperature sensors	10	10.4	Security Seals.....	16
	4.3.1 Pocket sensors with fixed cable	10			
	4.3.2 Pocket sensors without cable....	10			

1 Introduction

The HGP Meter is designed as Volume Meter and Energy Meters covering the flow range from 15 to 600 m³/h and are able to measure accurate flow rates of liquids with a conductivity > 10 µS/cm.

HGP meters are designed for measuring thermal heat energy in district heating and cooling systems or in the industry.

In addition to being an accurate and reliable heat energy and water meter for mains operation, the meter can also form part of systems for leak detection, data logging, process control etc.

1.1 Reference documents

Following documents are appendixes to this manual

- A.1 Volume Meters:
 - A.1.1 Data sheet HGP Volume Meter
 - A.1.2 Users manual for HGR/HGP Volume Meters
 - A.1.3 Installation manual for HGP Volume Meters
- A.2 Energy meters
 - A.2.1 Data sheet HGP Energy Meter
 - A.2.2 Users manual for HGP Energy Meters
 - A.2.3 Installation manual for HGP Energy Meters
- A.3 Analogue Box
 - A.3.1 Data sheet Analogue Box
 - A.3.2 Installation Guide HG Analogue Box (HG-420HF)
- A.4 Data sheet HG-LON module
- A.5 Display functions
- A.6 Type Approvals
 - A.6.1 Type Approval Certificate TS 27.01 075 for HGP Volume Meter with supplement 1 and 2 in Danish origin version
 - A.6.2 Type Approval Certificate TS 27.01 074 for HGP Energy Meter with supplement 1 and 2 in Danish origin version with English translation
 - A.6.3 Type Approval Certificate TS2701.132 for HGS intigration unit
- A.7 Communication protocol
 - A.7.1 Mbus protocol
 - A.7.2 Mbus data sheet
- A.8 Service instruments
 - A.8.1 HG-SER40 (=S40-10)
 - A.8.2 HG-SER 44

2 General description

HGP flow sensor is designed to measure water flow as a part of a volume meter stand alone unit and also function as volume meter for energy measurement.

The user accessible low-resolution volume pulse output can be programmed to either come from the main PCB directly or via the associated calculator/ display unit. The latter one has the limitation of maximal 1 pulse per measurement interval, while the first option permits up to 3 pulses. Refer to section 6.

The meter consists of a flow sensor with polished stainless steel electrodes and an electronic unit for wall mounting. The HGP-meter has a low pressure loss and contains no moving parts, which could be worn or choked up. The meter is very robust and is unaffected by excess flow. The flow sensor can be freely mounted horizontal, vertical or as required as long as it is filled with water. There is no need for straight length of pipe before or after the meter.

2.1 Design overview

General	
Accuracy	OIML R75 Class 4 / EN1434 Class 2
Approvals	OIML R75 Class 4 / TS 27.01-075
Dynamic range	1:250

Flow sensor	
Connection	from G2B / DN40 x 300 mm to DN150 x 500 mm
Liner	PTFE
Tube	AISI 304 (AISI 316 on request)
Flange	Mild steel (stainless steel on request)
Conductivity	> 0,5 mS/m [5µS/cm]
Electrodes	AISI 304 (AISI 316 on request)
Protection Class	IP54
Fluid temperature	t _{max} = 90 °C (design temp. 120 °C)
Pressure Class	PN16 (p _{max} = 16 bar abs.) - PN25 on request

Electronics	
Mains	230 VAC 50-60 Hz / option 24 V AC
Power consumption	< 7 Watt
Pulse output	Yes
Current output	Option
Mbus-Protocol	Yes
SIOX-Protocol	Yes
RS232- Communication	Yes
Pulse input (ext. meters)	Yes
Local indication, display	Yes
Protection Class	IP44

Fig 1: Design overview

2.2 Volume meter

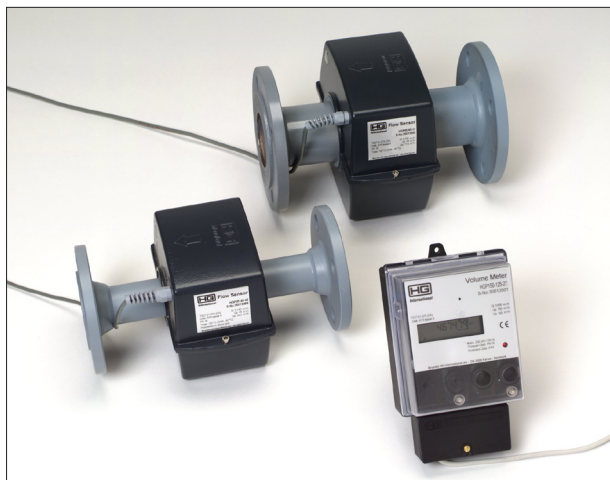

Fig 2: HGP volume meter

The HGP volume meters are made in following versions

- Version -07 works as flow meter without display but with pulse output for other manufacturers heat calculators. The measured volume output is provided as galvanic isolated pulses. See chapter 6.
- Version -27 is a volume meter and has two buttons for activating the display. The right button activates the display and with the left button you are able to see additional information such as peak values, stored data. The meter has pulse output and space for insertion of a communication module.
- Versions 174 is a volume meter using separate display unit of latest design with one push button. It has up to four menus with peak and averaged values of flow, stored data etc. The meter has pulse output, pulse input and space for insertion of a communication module for AMR-systems.

2.3 Heat energy meter



Fig 3: HGP energy meter

The HGP energy meter is based on above volume meter where the display unit performs the calculation of the integrated volume, the temperature difference between the flow

input and output and a constant factor (Dr. Stuck) measured by two accurate paired Pt100 or Pt500 sensors.

The calculation of energy is made on the basis of volume-based integrations. The integration interval is 1.28s on the larger versions (DN125 and DN250) the interval is 2.56s.

The HGP energy meters are made in following versions

- Version -44 has two buttons for activation of the display. The right button activates the display and with the left button you are able to see additional information such as peak values, stored data. The meter has pulse output for energy and volume, and also space for insertion of a communication module.
- Versions 184-188 are energy meters using separate display unit of latest design with one push button. It has up to four menus with peak and averaged values of power, flow and temperatures as well as stored data etc. The meter has pulse output, pulse input and space for insertion of a communication module for AMR-systems.

2.4 Flow sensors

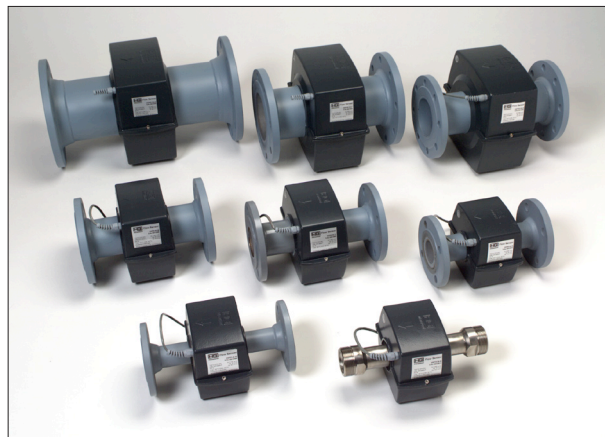

Fig 4: The HGP flow sensor family

The HGP-meter works fully electronically. The meter tube in the flow sensor is made of stainless steel lined with PTFE. The measuring principle is based on Faraday's magnetic induction principle, where the water movement induces a voltage across the electrodes.

The Faraday principle is commonly used where high precision measuring of flow is needed.

The HGP-meter has an extended measuring range better than 1 to 250, which means that it can measure flow velocity down to 0,4 % of the maximum flow.

2.5 Electronics

The electronic unit is based on microprocessor technology with following features

- Remote - surveillance and remote - access through serial data bus
- "Easy to read" LCD-Display with back light
- Error indication for loss of flow input.
- Visual indication of flow pulses
- In case of power dropouts all data are saved in an EEPROM
- Allows input and storage of pulses from water meters

- Programmable pulse output (litre/pulse value)
- Saves peak, total values and other data of up to 24 pre-defined periods of time
- Battery back-up for internal clock

2.6 Temperature sensors

The temperature sensors are 2-wire paired Pt100 temperature sensors with heat resistant silicone cable, according to EN60751 (IEC751) and EN1434. A Pt100 sensor is a resistance sensor with a nominal resistance of 100 Ohm at 0.00 °C, matched in pairs to ensure the needed accuracy.

Important: The cables may NOT be modified by any means.

2.6.1 Direct sensors

This sensor type is designed for fitting directly into the measuring medium to ensure fast response. The direct sensors are approved according to European standard EN 1434. Cable length max 8 metres, standard 3 metres.

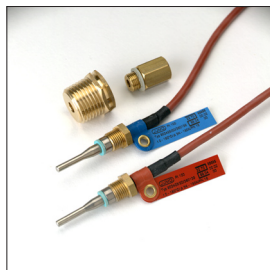

Fig 5: Direct sensors

2.6.2 Pocket sensors

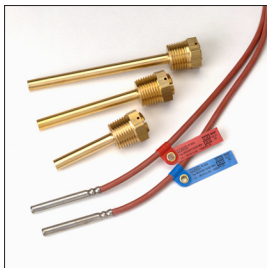

Fig 6: Pocket sensors



Fig 7: Head sensors

Pocket sensors can be replaced without shutting of the water as the pockets are fitted into the system before operation. On HGP meters pocket sensors are standard and different in lengths depending on pipe size. The pocket sensors are approved according to European standard EN 1434. The sensors with fixed cable are supplied from 3 (standard) to 8 metres length. The head sensors can have longer cables, see chapter 4.3.

2.7 Type approvals

The HGP meter series is designed to fulfil the European standard EN1434, and is approved according to the international recommendation OIML R75. The approvals are enclosed as appendixes to this manual comprising:

- Type Approval Certificate for HGP volume meter TS 27.01 075, Certificate no. 1997-4163-1013, date 01.07.1997
- Supplement No. 1 to TS 27.01 075, date 01.04.1999
- Supplement No. 2 to TS 27.01 075, date 05.05.1999

- Type Approval Certificate for HGP energy meter TS 27.01 074, Certificate no. 1997-4163-1012, date 1997-07-01
- Supplement No. 1 to TS 27.01 074, date 01.04.1999
- Supplement No. 2 to TS 27.01 074, date 05.05.1999
- Type Approval Certificate for HGS integration unit TS 27.01-132, Certificate no. 2003-7053-1836 date 2005-09-30

Approvals will be renewed when they expire in 2007

2.8 Accuracy

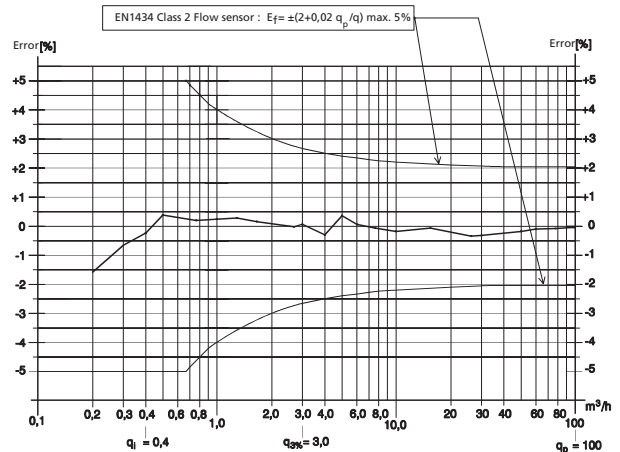

Fig 8: Typical accuracy of the HGP meter

The accuracy of the HGP volume meter is better than $\pm 2\%$ according to class 4 in OIML R75. In order to adapt the requirements to the European standard EN 1434, all HGP-meters are produced as class 2-meters according to EN 1434, meaning that the accuracy is better than:

Volume Meter: $\pm(2+0.02 q_p/q)\%$, but max $\pm 5\%$

Energy Meter: $\pm(3+4 \Delta\Theta_{\min} / \Delta\Theta + 0.02 q_p/q)\%$

2.9 Types and versions

HGP meter has following type description and ordering code

HGPxx-yy-zz/ab, see Fig 9

Example: HGP35-50-44/1M is an energy meter with max flow 35 m³/h, flange size DN50, display with 2-buttons, 230 VAC connection and inserted M-Bus module.

The HGP flow sensors have 3 measuring ranges:

- lower flow rate
- mid flow rate
- high flow rate

From fig 10 with meter sizes choice of flow rate is done from required size of connection flange and pressure drop.

Meter type		Max flow	Flange size	Version	Voltage	Communi- cation
HGP		xx	yy	zz	/ a	b
HGP with HGS integration unit	SIV					
15 m³/h		15	-	-	-	-
20 m³/h		20	-	-	-	-
35 m³/h		35	-	-	-	-
65 m³/h		65	-	-	-	-
90 m³/h		90	-	-	-	-
150 m³/h		150	-	-	-	-
250 m³/h		250	-	-	-	-
400 m³/h		400	-	-	-	-
600 m³/h		600	-	-	-	-
G2B thread		-	39	-	-	-
Flange DN40		-	40	-	-	-
Flange DN50		-	50	-	-	-
Flange DN65		-	65	-	-	-
Flange DN80		-	80	-	-	-
Flange DN100		-	100	-	-	-
Flange DN125		-	125	-	-	-
Flange DN150		-	150	-	-	-
Volume meter without display		-	-	07	-	-
Volume meter with 2 buttons		-	-	27	-	-
Volume meter with peak values		-	-	174	-	-
Energy meter with 2 buttons		-	-	44	-	-
Energy meter with peak values				184		
Energy meter with peak values and tariff				188		
Combined energy and cooling meter				185		
Voltage supply 230 V AC		-	-	-	1	-
Voltage supply 24 V AC		-	-	-	2	-
Communication module M-Bus		-	-	-	-	M
Communication module RS 232		-	-	-	-	R
Communication module LonWorks		-	-	-	-	L

Fig 9: HGP versions

Type			-39-	-40-	-50-	-65-	-80-	-100-	-125-	-150-
	Flange size	DN	G2B *)	DN40	DN50	DN65	DN80	DN100	DN125	DN150
	Length	mm	300	300	270	300	300	360	360	500
Lower flow rates:	q _{max}	m³/h	15	15	20	35	65	90	150	250
	q _{min}	l/h	60	60	80	140	260	360	600	1000
	Start flow	l/h	15	15	20	35	65	90	150	250
Medium flow rates:	q _{max}	m³/h	20	20	36	65	90	150	250	400
	q _{min}	l/h	80	80	144	260	360	600	1000	1600
	Start flow	l/h	20	20	36	65	90	150	250	400
High flow rates:	q _{max}	m³/h	35	35	65	90	150	250	400	600
	q _{min}	l/h	140	140	260	360	600	1000	1600	2400
	Start flow	l/h	35	35	65	90	150	250	400	600

*) threaded connection in stainless steel

Fig 10: HGP meter sizes

3 Operating principles

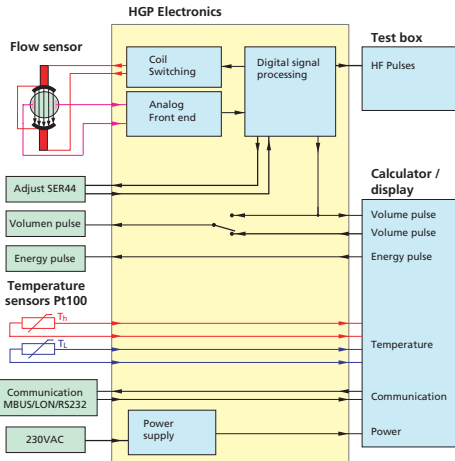

Fig 11: Design diagram

3.1 Volume measuring and signal processing

The measuring principle of the HGP-meter is based on Faraday's magnetic induction principle: When a conductor passes through a magnetic field a voltage is induced. This voltage is proportional to the velocity of the conductor. Within the HGP-meter the water represents the conductor.

The magnetic field - perpendicular to the water flow direction inside the flow sensor - is controlled by the Digital Signal Processing functions. The magnetic field combined with the velocity of the water generates a signal, which is received by the Analogue Front end Processing section. Subsequent to the analogue processing, the signal will be digitised and additionally processed by the Digital Signal Processing.

The Digital Signal Processing, carried out by the latest micro-processor technology, generates also the signals used for calibration (Test: Fast Pulse, refer to section 6. Input/output) and the calculator unit.

The Digital Signal Processing communicates simultaneously with Brunata HGP's intelligent calibration- and adjustment service instrument HG-SER44, via the serial connection Test / Cal. / Adj. (Refer to section 8).

By means of the software programmable parameter Energy/Flow on the main board it can be selected whether the volume pulses (Vol. Pulse) should be routed to the output terminals from the Digital Signal Processing, or from within the calculator unit where the energy is calculated.

Energy/Flow = 0: Flow Meter application. The flow pulse is routed to the galvanic separated flow output and to the input of the energy calculation unit as well.

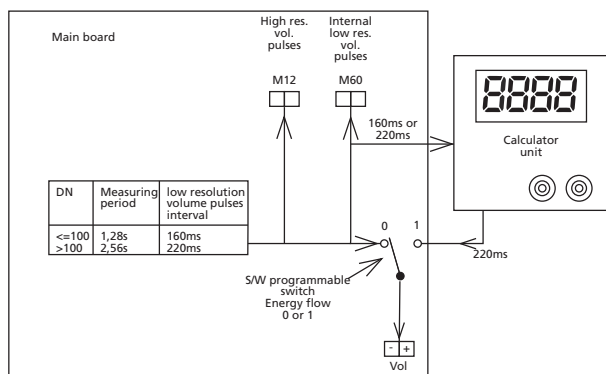

Fig 12: Block diagram

	Energy/Flow = 0: Flow Meter application.	Energy/Flow = 1: Energy and/or Flow Meter application	
DN	Low resolution volume pulses directly from main board: ON-time	Low resolution volume pulses generated by calculation unit. ON-time	High resolution volume pulses: Integration time slots
DN<=100	1.28 s	160 ms	160 ms
DN>100	2.56 s	220 ms	220 ms

Fig 13: Pulse description

Energy/Flow = 1: Energy and/or Flow Meter application. The flow pulse is routed solely to the input of the energy calculation unit, which in return provides the output volume pulse for the galvanic separated flow output.

Important: From the volume measurement up to 3 volume pulses can occur during a measuring interval. However the calculation unit is not able to process more than 1 pulse! This has to be taken into consideration when selecting the resolution in order to avoid flow measurement limitation. This will be covered in more detail in section 6.1 Volume pulse output .

The (low resolution-) energy pulse ON-time is always 220 ms.

3.2 HGP volume meter with HGS Integrator

The HF flow signal from the HGP volume meter is modulated and transferred to the HGS integrator, and integrated with the temperature signal in the micro processor.

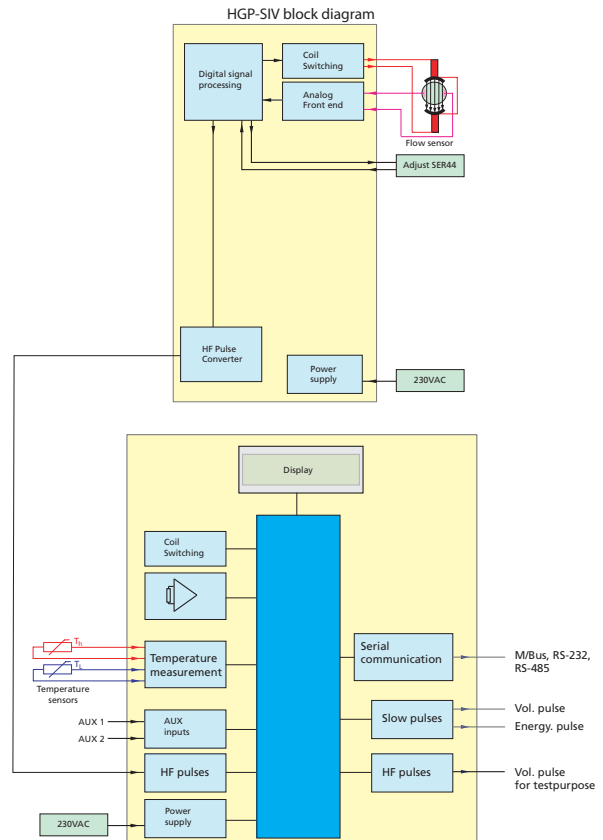

3.3 Temperature measuring

Two Pt100 or Pt500 temperature sensors are supplied as matched pair, selected by computer to ensure similar performance over the temperature range.

The temperature difference is shown with two decimals.

3.4 Energy calculation

A volume pulse starts the temperature measurement and the energy calculation. Together with every measurement the meter makes a self-calibration to ensure long term stability.

The HGP meter contains two volume registers. The first contains the value of water registration used for energy calculation and the second the total value. A comparison of the two registers will show whether and for what volume the meter has been out of order, due to f.inst. manipulation or faulty temperature sensors.

The energy is calculated according to the formula in OIML R75, which simplified can be summed up as follows:

$$E = V \times \Delta\Theta \times k$$

V is the water volume flow velocity

$\Delta\Theta$ is the difference between the flow and the return temperature ($t_f - t_r$)

k is the water heat coefficient (enthalpy) from Dr. Stuck's table.

All current registers are automatically stored in EEPROM every 24 hours. If the meter shall be disconnected from the mains because of service etc. you can always store the current reading by pressing the right button for approx. 8 seconds.

3.5 Display functions

Refer to the Users Manuals in the Appendix section A:

- A.1.2 Users manual for HGR/HGP Volume Meters and
- A.2.2 Users manual for HGP Energy Meters and
- A.5 Display functions

3.6 Flow rates above q_{max}

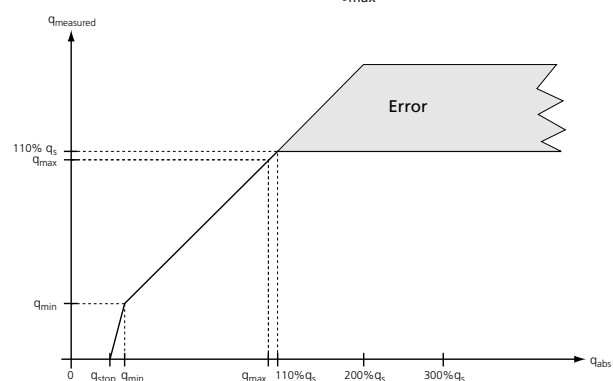

Fig 14: Flow rates > q_s

When the flow rate exceeds 110 % of the maximum flow (150 % on HGS integrator see HGQ/HGS manual), the meter will constantly register 110 % of q_{max} . That means there is no stop or interference's at higher flow rates and no error indication will occur. When the flow rate returns to the normal measuring range the meter registers correct again.

NOTE: It is not possible to damage the flow sensor by overload!

3.7 Info and error codes, self test

The HGP activates a self-test cycle for every measurement. The microprocessor checks that the temperature / resistance measurements values are correct by measuring built-in precision resistors. In the event of faulty measurements, and when the temperature sensors are broken or short-circuited, the display gives an error message.

A supervision of flow pulses gives a warning if no flow pulses have been registered during the last 24 hours.

In case of an error the Message "ERROR" will be displayed and the following signs will indicate the kind of the error:

- t1 Forward temperature sensor defective or missing
- t2 Return temperature sensor defective or missing

If the temperature symbol t1 or t2 is underlined the sensor is short-circuited, if the symbol is overlined, the temperature sensors are broken or missing.

- an X across the water drop icon NO flow or defective flow sensor

4 Dimensions

4.1 Flow sensors

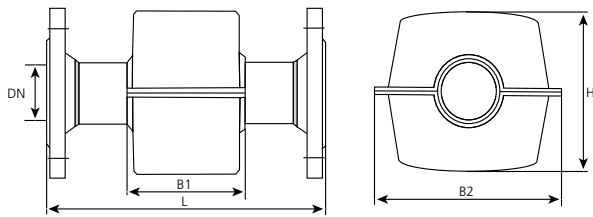

Fig 15: HGP flow sensor

Flange	L [mm]	H [mm]	B1 [mm]	B2 [mm]	Weight [kg]
G2B ¹⁾	300	164	116	186	7
DN40	300	164	116	186	9
DN50	270	164	116	186	11
DN65	300	194	118	216	14
DN80	300	194	118	216	16
DN100	360	268	152	286	26
DN125	360	268	152	286	34
DN150	500	268	152	286	37

1) 2 Inch thread

4.2 Electronics

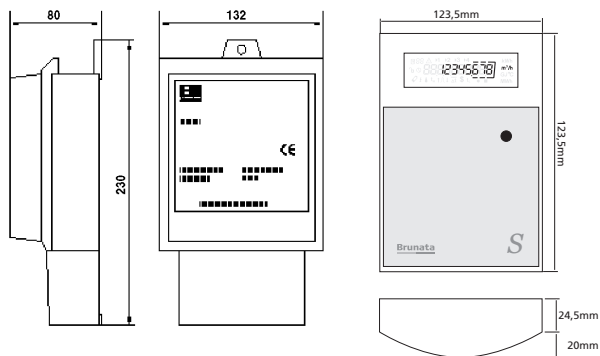

Fig 16: HGP Electronic units

4.3 Temperature sensors

4.3.1 Pocket sensors with fixed cable

These sensors are standard for all HGP energy meters. Pockets are available in solid brass or in stainless steel AISI 316.

Standard for HGP meters:

Flow sensor size	Cable length	Pocket dimensions	Material
DN 40-50	3 m	R½ x 85 mm	Brass
DN 65-100	3 m	R½ x 120 mm	Brass
DN 125-150	3 m	R½ x 210 mm	Brass

Fig 17: Temperature sensor pockets

Pt100 or Pt 500 Pocket sensor

Cable length [metres]	Cable dimension [mm ²]	Max. sensor temperature [°C]	Max. cable temperature [°C]	Max. temp. difference [Kelvin]
1.5	0.22	150	180	3-150
3.0				
5.0				
8.0				

Fig 18: Temperature sensors with cable

4.3.2 Pocket sensors without cable

Pocket sensors without cable are use where longer cables as 8 metres are needed, or for special installation f.inst. where more sensors are needed in one pipe.

Cable length [metres]	Cable dimension [mm ²]	Cable material	Max. cable temp. [°C]
5	0.75	Silicone	175
8	0.75		
10	1.00		
12	1.00		
15	1.00		
18	1.50		
20	1.50		
25	1.50		

Fig 19 Head temperature sensors without cable

Pocket dimensions	Flow sensor size	Material	Max. sensor temp. [°C]	Max. temp. difference [Kelvin]
G½ x 85 mm	DN 40-50	Stainless steel	180	3-180
G½ x 120 mm	DN 65-100	AISI 316T		
G½ x 210 mm	DN 125-150	(1.4571)		

Fig 20: Pockets for head sensors

5 Pressure ratings and flow ranges

The volume flow rate is a function of the flow velocity and the size of the pipe. Therefore the pressure drop in each sizes f.inst. DN40, is the same regardless of the programmed

q_{max} .

Minimum and maximum flow and DN:

Meter	q_{min} [l/h]	q_{max} [m ³ /h]	DN
HGP15-YY-ZZ	60	15	40
HGP20-YY-ZZ	80	20	40, 50
HGP35-YY-ZZ	140	35	40, 50, 65
HGP65-YY-ZZ	260	65	50, 65, 80
HGP90-YY-ZZ	360	90	65, 80, 100
HGP150-YY-ZZ	600	150	80, 100, 125
HGP250-YY-ZZ	1000	250	100, 125, 150
HGP400-YY-ZZ	1600	400	125, 150
HGP600-YY-ZZ	2400	600	150

YY: DN Size 40, 50, 65, 80, 100, 125 or 150 (see "chapter 2.9")

ZZ: Version 07: Volume meter, No display

Version 17 and 27: Volume meter with display

Version 42 and 44 Energy Meter

Fig 21: Flow rates

Table Fig 22 shows max pressure loss at max. flow for the different flow sensor size.

Flow Sensor Size DN		40	50	65	80	100	125	150
Max. flow (q_p)	[m ³ /h]	35	65	90	150	250	400	600
Max. pressure loss at q_p	[kPa]	14	15	9	9	9	10	9
Flow at $\Delta P = 10$ kPa	[m ³ /h]	28	50	95	170	270	400	640

Fig 22: Pressure drop table

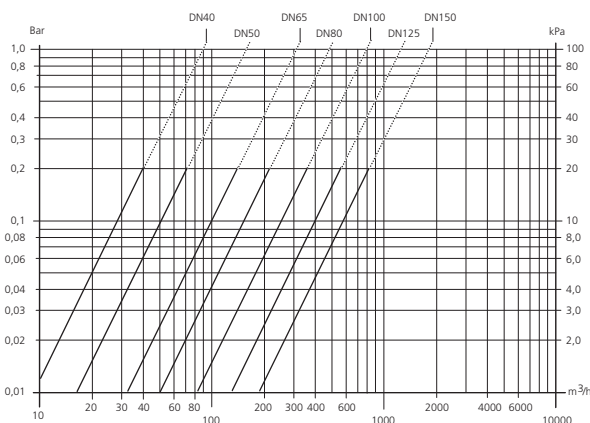

Fig 23: Pressure drop diagram

6 Terminal connection

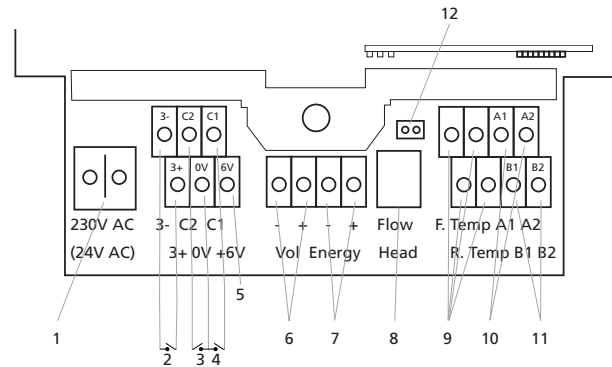

Fig 24: Terminal connection

Nr.	Name	Function / Specification
1	Mains	230 Volt +10% -15% 50-60 Hz / Option 24 VAC
2 ¹⁾	3. External pulse input	3. Pulse input from external meter / counter. (not standard)
3 ¹⁾	2. External pulse input	2. Pulse input from external meter / counter. (standard)
4 ¹⁾	1. External pulse input	1. Pulse input from external meter / counter. (standard)
5	+6V	External +6 Volt max. 5mA (for ext. calculator)
6	Volume pulse output	Open-collector pulse output max. 20 mA 28 Volt. (see also test and adj.)
7	Energy pulse output	Open-collector pulse output max. 20 mA 28 Volt. (last digit in display)
8	Flow-head	The input from the flow sensor
9 ¹⁾	F. Temp	The connection from the Pt100 temperature sensor in the Flow pipe
9 ¹⁾	R. Temp	The connection from the Pt100 temperature sensor in the Return pipe
10 ¹⁾	A1, B1	1. Serial communication connection MBus / SIOX / LON / RS232
11 ¹⁾	A2, B2	2. Serial communication connection MBus / RS232 / LON parallel to A1, B1
12	HF	High resolution volume output (see test and adjustment)

¹⁾ Only for energy meters and flow meters with display

Terminal connection HGS integrator, See HGQ/HGS manual.

6.1 High resolution volume pulse output

The two-pin connector M12 is the high-resolution volume pulse output (HF-Pulses). Pin 1, the pin to the left, is 0 Volts. Pin 2 is the signal pin.

The quadrangle curve states the duration of a pulse train plus the spaces in between. Notice: Every 'top' of the quadrangles symbolises a pulse train of maximum 5,500 pulses, with a frequency of approx. 77 kHz in the pulse train. Each pulse train is occupying up to 72ms and is composed of a number of smaller pulse trains.

The HGP flow meters have been designed to transmit 25,000 pulses at maximum flow. If the pulse frequency is larger than 22000 it can not be transmitted during a period of 4x72ms and an extra pulse train is 'attached' (sequence part 3). This is prior to the 4 mandatory (sequences part 4-7).

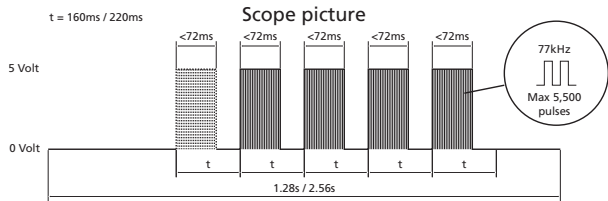

Fig 25: Flow pulse

A few examples:

From the preceding sequence it was calculated that 12,000 pulses must be transmitted: 4x3,000 pulses are transmitted within metering sequence 4 - 7. The duration of each individual pulse train will therefore be: $(3,000/77 \text{ kHz}) = 39\text{ms}$.

When the flow is at a maximum, 25,000 pulses must be transmitted: 4x5,500 pulses are transmitted within metering sequence 4 - 7, plus 3,000 pulses within sequence 3. The duration of the pulse trains will be respectively 72ms and 39ms.

The maximal duration of the pulse train, which is transmitted within sequence 3, is therefore 39ms.

The output has been secured against short circuit with a 1 kOhm resistor placed in series, which limits the current to 5mA.

From the pulse-timing scheme it can be seen that the total measuring period of 1.28s (or 2.56s when DN>100 is applied) is divided into a number of sub-periods of 160ms each. However these sub-periods with their 77kHz pulse trains are 220ms long, when the measuring period is 2.56s.

6.1.1 The values of the high resolution (HF-) volume pulses

Adjustment:

1. The flow is set to q_{max} . This makes the meter generate 25,000 pulses every 1.28s. However for DN>100 every 2.56s.
2. The GAIN factor is adjusted with the HG-SER44 terminal so that the number of pulses is within the wanted accuracy ($\pm 0,5\%$) e.g. HGP35 after 10min./5833.33 litre = 11,718.750 pulses.
3. The flow is set to q_{min} . This makes the meter generate 100 pulses per 1.28s. / 2.56s.

HG-Meter type	Max-flow [l/h]	Min-flow [l/h]	Measuring period [sec]	LF-pulse [litre/Pulse]	Flow Pulse Setting	HF [Pulses / litre]
HGP15-39-ZZ	15,000	60	1.28	10	367	4,687.5000
HGP15-40-ZZ	15,000	60	1.28	10	367	4,687.5000
HGP20-39-ZZ	20,000	80	1.28	10	275	3,515.6250
HGP20-40-ZZ	20,000	80	1.28	10	275	3,515.6250
HGP20-50-ZZ	20,000	80	1.28	10	275	3,515.6250
HGP35-39-ZZ	35,000	140	1.28	25	393	2,008.9286
HGP35-40-ZZ	35,000	140	1.28	25	393	2,008.9286
HGP35-50-ZZ	35,000	140	1.28	25	306	1,562.5000
HGP65-50-ZZ	65,000	260	1.28	25	212	1,081.7308
HGP65-65-ZZ	65,000	260	1.28	25	212	1,081.7308
HGP65-80-ZZ	65,000	260	1.28	25	212	1,081.7308
HGP90-65-ZZ	90,000	360	1.28	100	611	781.2500
HGP90-80-ZZ	90,000	360	1.28	100	611	781.2500
HGP90-100-ZZ	90,000	360	1.28	100	611	781.2500
HGP130-100-ZZ	130,000	520	1.28	100	423	540.8654
HGP130-125-ZZ	130,000	520	1.28	100	212	270.4327
HGP150-100-ZZ	150,000	600	1.28	100	367	468.7500
HGP150-125-ZZ	150,000	600	2.56	100	183	234.3750
HGP175-125-ZZ	175,000	700	2.56	100	157	200.8929
HGP250-100-ZZ	250,000	1,000	1.28	100	220	281.2500
HGP250-125-ZZ	250,000	1,000	2.56	100	110	140.6250
HGP250-150-ZZ	250,000	1,000	2.56	100	110	140.6250
HGP400-125-ZZ	400,000	1,600	2.56	250	175	87.8906
HGP400-150-ZZ	400,000	1,600	2.56	250	175	87.8906
HGP600-150-ZZ	600,000	2,400	2.56	250	115	58.8938
Flow pulse Setting						
HGP(1,28)	X	X:250			$550 \times (l/p) / q_{\text{max}}$	
HGP(2,56)	X	X:250			$275 \times (l/p) / q_{\text{max}}$	

- ZZ 07: Volume meter without display
 17: Volume meter standard, one button
 27: Volume meter with extended functions, two buttons
 42: Energy meter standard, one button
 44: Energy meter with extended functions, two buttons

Fig 26: Flow pulse setting

4. After a suitable volume e.g. 10, 40 or 100 litre's, the accumulated pulses is compared to the wanted number of pulses e.g. HGP20 after 15min./ 20l. = 40,179 pulses. The OFFSET factor is adjusted with the HG-SER44 terminal so that the number of pulses is within the wanted accuracy. $\pm 0.5 \%$

6.2 Low resolution volume output

Setting the low resolution volume pulse value:

The open collector volume pulse output with an active low time t_{ON} of 160ms at 1,28s measuring time and 220ms at 2.56s measuring time can be set to different litre/pulse values, with the only limitation of a maximum of approx. 2 pulses every second (2Hz). The maximum pulse count during the measurement interval of 1.28s is internally limited to 3, which means that the minimum time between 2 pulses is determined by $(1.28/3) s \sim 0.45s$ and this in return can be recalculated to $(1/0.45)Hz = 2.2Hz$ at 1.28s measurement interval and 1.1 Hz at 2.56s

With serviceinstrument SER44 the pulse value can be programmed. If for instance a 25 litre pulse is wanted with a HGP35, the + Flow pulse is set to 393 :

HGP35-YY-ZZ ; 550 x 25L/P / 35 = 392.85714 = 393 flow pulse setting.

The low-resolution pulses are taken out on the -VOL+ terminals.

The low-resolution output pulses are an open-collector opto-coupler output.

See chapter 3 for further description.

6.2.1 Maximum flow without calculator

When the meter is not equipped with a calculator and display (type -07) the maximum low resolution output pulses is 3 pulses per measurement period (1.28s or 2.56s). The duration t_{ON} of the pulses is 50ms. This means that the maximum flow with e.g. 25 litre / pulse is:

This also applies to meters with display where the pulses are directed to the mainboard (setting = 0), ref. chapter 3.1

- Measurement periods / hour
 $n = 3,600s / 1.28s = 2,812.5$
- The integer N form $n = 2812$
 $q_{max} = 2,812 \times 3 \times 25litre/h = 210m^3/h$

For other scaling factors refer to Fig 28.

6.2.2 Maximum flow with calculator

When the meter is equipped with a calculator unit and display, the low-resolution output pulses can be programmed to be delivered either from the calculator unit or directly from the HGP electronics.

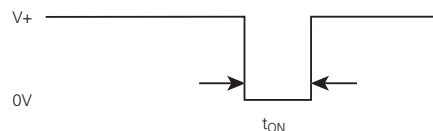

Fig 27: Pulse curve

The measurement period is 1.28s or 2.56s dependent of the flow sensor. The maximum pulse count per measurement interval is 1.

The maximum measurable flow rate q_{max} is determined by means of the litre / pulse scaling factor. E.g. with a scaling factor of 25 litre / pulse:

- Measurement periods / hour
 $n = 3,600s / 1.28s = 2,812.5$
- The integer N form $n = 2,812$
 $q_{max} = 2,812 \times 25litre/h = 70.3 m^3/h$

For other scaling factors refer to Fig 28.

Note: Up to SW version 2.5, the pulse length t_{ON} (active low) was 40ms. From version 2.6 this is changed to 160ms

Litre / pulse	$q_{max} [m^3/h]$			
	With calculator		Without calculator	
	Period 1.28s	Period 2.56s	Period 1.28s	Period 2.56s
0.1	0.3	0.1	0.8	0.4
0.25	0.7	0.4	2.1	1.1
1	2.8	1.4	8.4	4.2
2.5	7.0	3.5	21	11
10	28.1	14.1	84	42
25	70.3	35.2	211	105
100	281.3	140.6	844	422
250	703.1	351.6	2,109	1,055
1,000	2,812.5	1,406.3	8,438	4,219

Fig 28: Max. flow at different pulse values

7 Data communication

Communication modules within the calculator unit handle the serial data communication with its hardware modules M-Bus, RS232 and LON.

The available modules are small plug-in circuits on a pin strip. The modules can be used in all Brunata volume and energy meters. The modules are powered from the meter.

Essential registers within the calculator unit can be accessed via standard M-Bus protocol, as specified in the European standard EN1434, part 3.

The M-Bus protocol is described in Appendix A7.

7.1 RS232 module

The Brunata RS232 module is designed according to RS232 standard, thus a d-sub plug can be connected directly into a PC and the cable terminated to the meter, refer to table Fig 30.

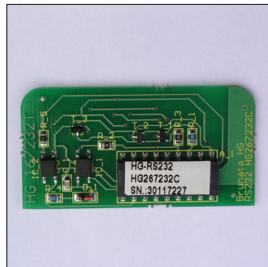

Fig 29: RS232 Module

PC	HGP
d-sub-9 female	Communication Terminals
1, 6, 4	A1
5	A2
2	B1
3	B2
7, 8	Not connected

Fig 30: RS232 Cable connections

7.2 M-Bus module

The Mbus communication module is a small Plug In module, which is to be mounted on a pin strip in all Brunata volume and energy meters. It is powered from the meter.

Refer to Appendix A.7:

- Mbus protocol

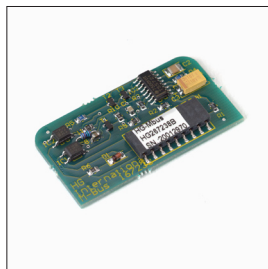

Fig 31: Mbus module

7.3 LON module

Refer to Appendix A.4 HG-LON. Using LON module the meter can communicate according to FTT10A standard used in for example building automation systems.

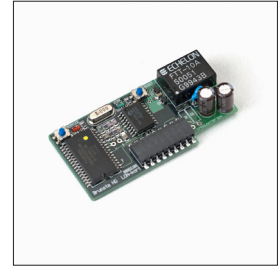

Fig 32: LON module

7.4 Analogue output device

A 4-20mA current source type HG420HF is available in 5 variants. All have $q_{min} = 4mA$ in common, while the following percentages of $q_{max} (= 20mA)$ can be ordered: 76%, 75%, 80%, 83% and 100%. This permits to choose a type for best output current resolution of the actual q_{max} . The max. load resistance is 600 Ohm.



Fig 33: HG Analogue Box

The current signal is based on the internal HF signal taken out in 2 galvanic separated terminals (terminal 12, see chapter 6)

Refer to Appendix A.3

Analogue device for the HGS integrator type HG420SD is a flow-to-current converter, where the serial flow signal is converted to a 4-20 mA signal. The flow signal is updated every 1.6 seconds.

7.5 Communication

To communicate using a modem, the meter needs the RS232 module installed. Modems can be either for PSTN or GSM. The modem shall have support for 11-bit communication.

Several modems can provide support for either 10-bit or 11-bit communication. Each of these modems is factory configured for default 10-bit communication. To configure a local modem for 11-bit communication, consult the manual for the modem.

The baudrate used in the meter is 2400 baud.

8 Test and adjustment

8.1 Calibration / Verification

Calibration and revification is done according to MDIR nr. 27.01-01 and OIML R75 class 4 standards, with special attention to the text in the type approval, see Appendix A.6

Connection for SER44 instrument

Reference conditions:

Fluid temperature:
20 °C ± 5 K

Ambient temperature:
20 °C ± 5 K

Warm up time:
30 Minutes

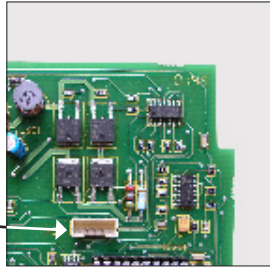

Fig 34: Service instrument connection

8.2 Service Instruments

8.2.1 HG-SER 40

HG-SER40 (identical with S40-10) is used for test and adjustment of the calculation unit.

Refer to Appendix A.8.1 : Service instrument S40



Fig 35: HG-SER 40 Service instrument

8.2.2 HG-SER 44

HG-SER 44 is intended for calibration and test of the part of the meter. It is also used for selecting the pulse output according to chapter 3.1. Refer to Appendix A.8.2: HG-SER 44

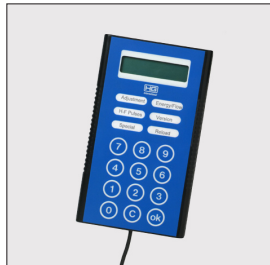

Fig 36: HG-SER 44 Service instrument

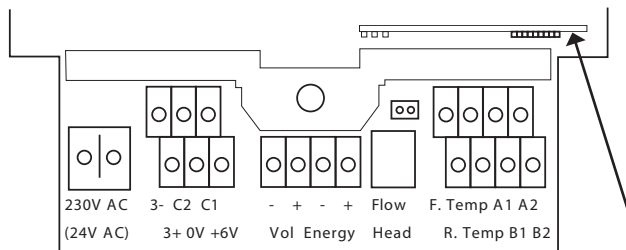

Fig 37: Communication module connection

9 Change of display functions

The display functions are depending on chosen meter type and cannot be changed by user. Refer to section 3.4 Display functions.

For HGS integrator please consult the HGQ/HGS manual.

9.1 Zeroing of peak values

The peak and mean values are reset at each accounting date.

9.2 Date and Clock adjustment

Date and clock are factory set and are adjustable with the service instrument HG-SER40.

9.3 Battery

The internal Lithium battery ensures backup of date, clock, set up and data in care of no mains supply. In case of low battery no measuring data are lost as they are saved in EEPROM, but the clock has to be set again. There is no "Low battery" warning available. Battery lifetime is estimated to be 8-10 years.

10 Installation requirements

10.1 Installing the flow sensor

The Flow Sensor must be installed in the return pipe, unless it is specified for the flow pipe (see data on the meter label). The arrow on the housing must point in the flow direction! There are no requirements regarding straight pipe sections before or after the Flow Sensor, only the meter must always be filled with water. Never insulate the housing of the Flow Sensor.

10.2 Mounting and Connections of the Electronic Unit

The HGP electronic unit is a wall mounted piece of equipment, which should be installed in reachable distance from the flow sensor and temperature sensors and in an indoor environment. Mount the box on a flat surface using 3 screws and make sure the lid of the box easily can be opened and removed.

All connections must be finished before connection to the mains!

The cable from the Flow Sensor is inserted into the socket marked Flow Head. Note the locking system and how the cable exits the box. Never shorten or coil the cable, but fasten it carefully. When disconnecting the cable from the socket the locking strap should be prised up using a small screwdriver.

The power cable (230 or 24 VAC) is inserted through the strain-relief, which must be tightened before tightening the terminal connections.

Be sure that the meter runs. Please note, that the meter display updates only when water pulses are generated.

10.3 Temperature sensors

The two temperature sensors are marked red and blue indicating high and low temperature. The meter is delivered with pocket sensors, but it can also be delivered with sensors for direct installation.

When using pocket sensors a min. of 20mm of the pocket must be placed in the middle of the water flow. To install the sensors, they are pushed into the pocket, and the cable should be twisted backwards and forward a few times to be sure that the sensor goes down into the bottom of the sensor pocket. After fastening the terminal screw, the sensor can be sealed through one of the three small holes.

10.4 Security Seals

From the factory the meter is sealed through the transparent lid and the screw. After mounting and connecting the Electronic Unit the black lid is mounted and the unit can be sealed using sealing wire and a standard seal.

Additionally the meter has two factory seals inside the Electronic Unit: One on the Connection PCB and another one on the Display PCB. Because of this sealing it is possible to access the Unit to install a Data Communication module and to make local verification of the meter.